



Tavolo con top in legno massello a liste incollate con bordi smussati, caratterizzato da due gambe composte ognuna da due volumi dalle forme morbide, una in ferro e l'altra in legno, che si incontrano a creare un gioco di incroci ispirato alle forme osservabili nella natura incontaminata.



COD.	DIMENSIONI	BASE	A1	A2	A4
CROSS 1	L.240 x P.120 x H.75	B2	■	■	■
		B3	■	■	■
CROSS 2	L.260 x P.120 x H.75	B2	■	■	■
		B3	■	■	■
CROSS 3	L.280 x P.120 x H.75	B2	■	■	■
		B3	■	■	■
CROSS 4	L.300 x P.120 x H.75	B2	■	■	■
		B3	■	■	■

FINITURE DISPONIBILI

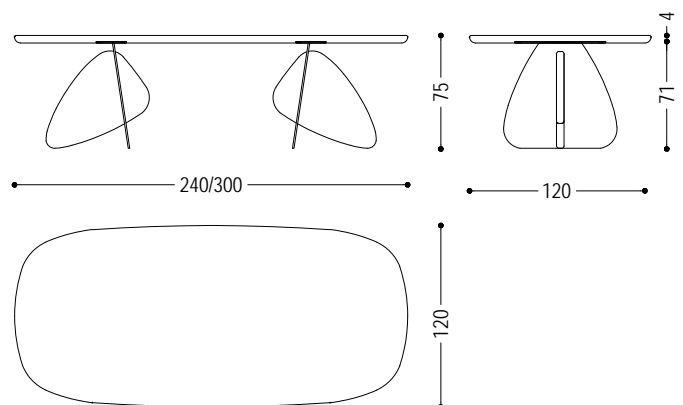
- A1:** noce senza nodi, noce con nodi
- A2:** rovere senza nodi, rovere con nodi, ciliegio
- A4:** rovere senza nodi pigmentato: bianco latte, total black
rovere con nodi pigmentato: bianco latte, total black
- B2:** ferro laccato: iron dust, RAL (solo colori selezionati)
- B3:** ferro laccato effetto spazzolato opaco: bronzo antico, acciaio, titanio



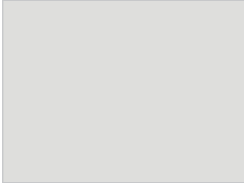

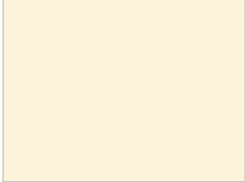
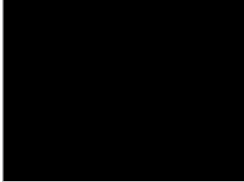
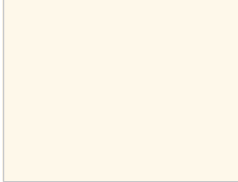
FERRO

B2					
	ferro laccato: iron dust	ferro laccato: RAL - 1013_BIANCO PERLA	ferro laccato: RAL - 3020_ROSSO TRAFFICO	ferro laccato: RAL - 7035_GRIGIO LUCE	ferro laccato: RAL - 7037_GRIGIO POLVERE
					
	ferro laccato: RAL - 8019_MARRONE GRIGIASTRO	ferro laccato: RAL - 9001_BIANCO CREMA	ferro laccato: RAL - 9002_BIANCO GRIGIASTRO	ferro laccato: RAL - 9005_NERO INTENSO	ferro laccato: RAL - 9010_BIANCO PURO
					
	ferro laccato: RAL - 9016_BIANCO TRAFFICO				

B3			
	ferro laccato effetto spazzolato opaco: bronzo antico	ferro laccato effetto spazzolato opaco: acciaio	ferro laccato effetto spazzolato opaco: titanio

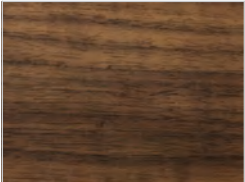
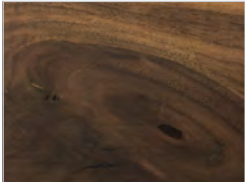
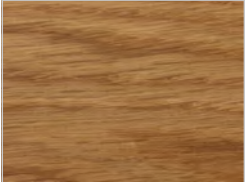
LEGNO

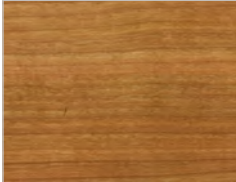
A1			
	noce senza nodi	noce con nodi	
A2			
	rovere senza nodi	rovere con nodi	ciliegio

A4



rovere senza nodi pigmentato:
bianco latte

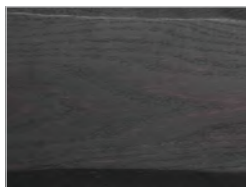

rovere senza nodi pigmentato:
total black



rovere con nodi pigmentato:
bianco latte



rovere con nodi pigmentato:
total black