



Tavolo con top in legno massello a liste incollate e bordi smussati, che si caratterizza per le gambe, nate dall'incontro tra ferro e legno e create per apparire diverse a seconda dell'angolazione da cui le si guarda.

COD.	DIMENSIONI	BASE	A1	A2	A4
FORMA 1	L.200 x P.100 x H.76	B2	■	■	■
		B3	■	■	■
		B4	■	■	■
		B5	■	■	■
FORMA 2	L.220 x P.100 x H.76	B2	■	■	■
		B3	■	■	■
		B4	■	■	■
		B5	■	■	■
FORMA 3	L.240 x P.100 x H.76	B2	■	■	■
		B3	■	■	■
		B4	■	■	■
		B5	■	■	■
FORMA 4	L.260 x P.100 x H.76	B2	■	■	■
		B3	■	■	■
		B4	■	■	■
		B5	■	■	■
FORMA 5	L.280 x P.100 x H.76	B2	■	■	■
		B3	■	■	■
		B4	■	■	■
		B5	■	■	■
FORMA 6	L.300 x P.100 x H.76	B2	■	■	■
		B3	■	■	■
		B4	■	■	■
		B5	■	■	■

FINITURE DISPONIBILI

A1: noce senza nodi, noce con nodi

A2: rovere senza nodi, rovere con nodi, ciliegio

A4: rovere senza nodi pigmentato: bianco latte, total black
 rovere con nodi pigmentato: bianco latte, total black

B2: ferro laccato: iron dust, RAL (solo colori selezionati)







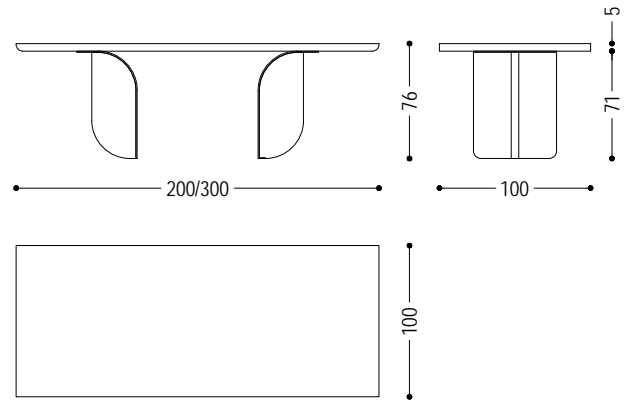

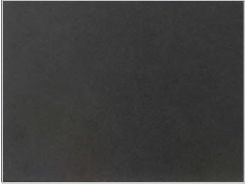
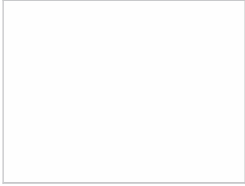

B3: ferro laccato effetto spazzolato opaco: bronzo antico, acciaio, titanio

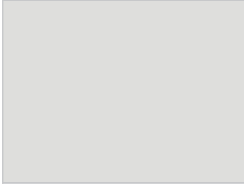
B4: ferro laccato: RAL speciale

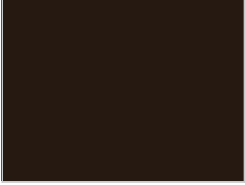
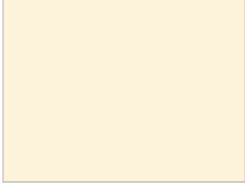
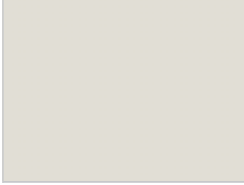
B5: ferro laccato: bronzo nuvolato

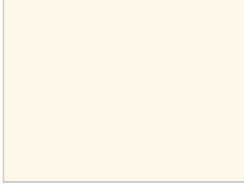
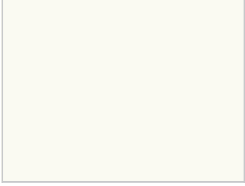

FERRO

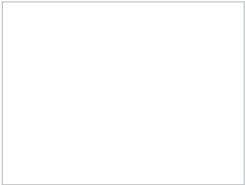
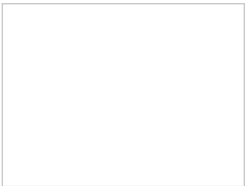
B2					
					
					
B3					
					
					

LEGNO

A1

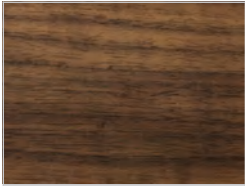

noce senza nodi



noce con nodi

A2

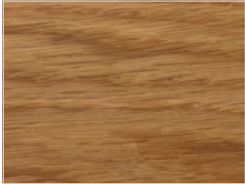

rovere senza nodi



rovere con nodi



ciliegio

A4

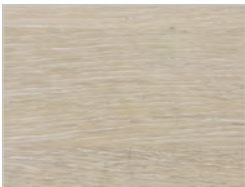

rovere senza nodi pigmentato:
bianco latte

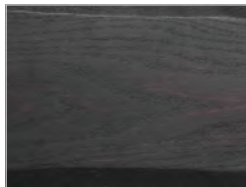

rovere senza nodi pigmentato:
total black



rovere con nodi pigmentato:
bianco latte



rovere con nodi pigmentato:
total black