



Il tavolo presenta un top costituito dall'accostamento di più doghe ricurve intervallate da inserti di resina nera. Le gambe, composte ciascuna da due anelli ovali in ferro, riprendono la forma curva delle doghe del top.

COD.	DIMENSIONI	BASE	DOGHE ROVERE
HYPNOTIC	L.240 x P.95/110 x H.75,5	B2	■
		B3	■







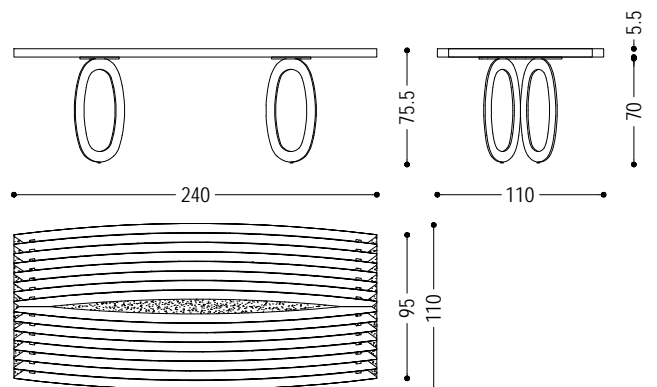

FINITURE DISPONIBILI:

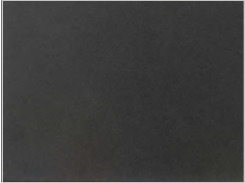
B2: ferro laccato: irondust, RAL (solo colori selezionati)

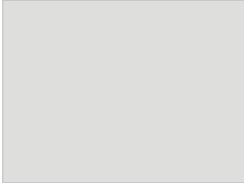
B3: ferro laccato effetto spazzolato opaco: bronzo antico, acciaio, titanio

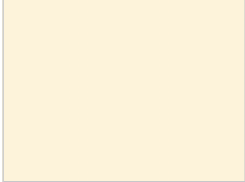
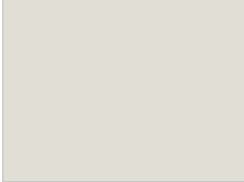
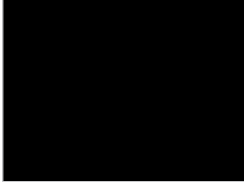
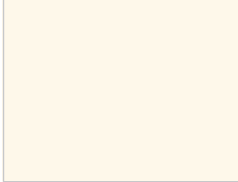
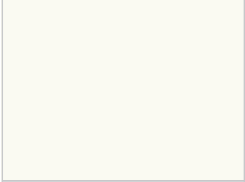

FERRO

B2					
	<p>ferro laccato: irondust</p>	<p>ferro laccato: RAL - 1013_BIANCO PERLA</p>	<p>ferro laccato: RAL - 3020_ROSSO TRAFFICO</p>	<p>ferro laccato: RAL - 7035_GRIGIO LUCE</p>	<p>ferro laccato: RAL - 7037_GRIGIO POLVERE</p>
					
	<p>ferro laccato: RAL - 8019_MARRONE GRIGIASTRO</p>	<p>ferro laccato: RAL - 9001_BIANCO CREMA</p>	<p>ferro laccato: RAL - 9002_BIANCO GRIGIASTRO</p>	<p>ferro laccato: RAL - 9005_NERO INTENSO</p>	<p>ferro laccato: RAL - 9010_BIANCO PURO</p>
					
	<p>ferro laccato: RAL - 9016_BIANCO TRAFFICO</p>				
B3					
	<p>ferro laccato effetto spazzolato opaco: bronzo antico</p>	<p>ferro laccato effetto spazzolato opaco: acciaio</p>	<p>ferro laccato effetto spazzolato opaco: titanio</p>		