



Tavolo con top in legno massello a liste incollate, caratterizzato da spessori assottigliati tramite lavorazione a saponetta per donare leggerezza e sinuosità, abbinato a gambe in ferro che si avvolgono su se stesse ad evocare la flessibilità di un nastro.

COD.	DIMENSIONI	BASE	A1	A2	A4
<b>NASTRO 1</b>	L.200 x P.100 x H.76	B2	■	■	■
		B3	■	■	■
		B4	■	■	■
		B5	■	■	■
<b>NASTRO 2</b>	L.220 x P.100 x H.76	B2	■	■	■
		B3	■	■	■
		B4	■	■	■
		B5	■	■	■
<b>NASTRO 3</b>	L.240 x P.100 x H.76	B2	■	■	■
		B3	■	■	■
		B4	■	■	■
		B5	■	■	■
<b>NASTRO 4</b>	L.260 x P.100 x H.76	B2	■	■	■
		B3	■	■	■
		B4	■	■	■
		B5	■	■	■
<b>NASTRO 5</b>	L.280 x P.100 x H.76	B2	■	■	■
		B3	■	■	■
		B4	■	■	■
		B5	■	■	■
<b>NASTRO 6</b>	L.300 x P.100 x H.76	B2	■	■	■
		B3	■	■	■
		B4	■	■	■
		B5	■	■	■

**FINITURE DISPONIBILI**







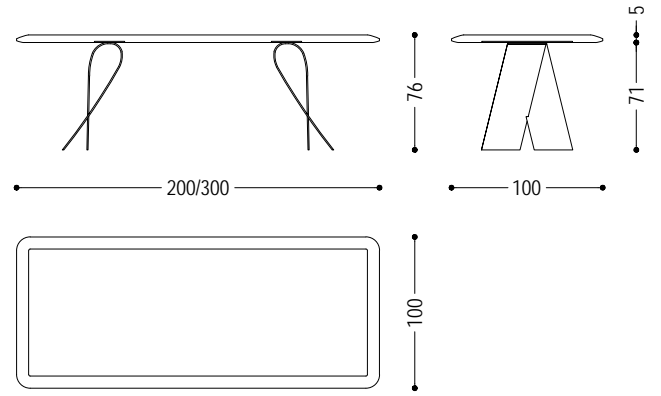

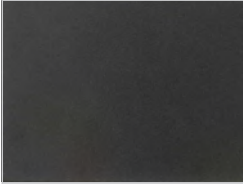
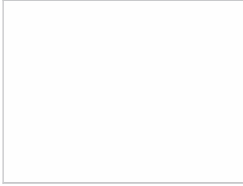

- A1:** noce senza nodi, noce con nodi
- A2:** rovere senza nodi, rovere con nodi, ciliegio
- A4:** rovere senza nodi pigmentato: bianco latte, total black  
rovere con nodi pigmentato: bianco latte, total black
- B2:** ferro laccato: iron dust, RAL (solo colori selezionati)
- B3:** ferro laccato effetto spazzolato opaco: bronzo antico, acciaio, titanio
- B4:** ferro laccato: RAL speciale
- B5:** ferro laccato: bronzo nuvolato

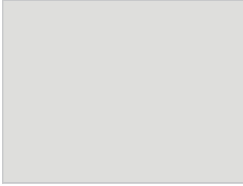
# NASTRO

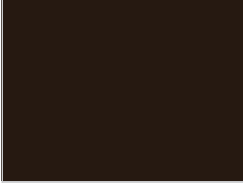
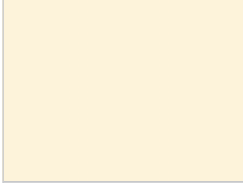
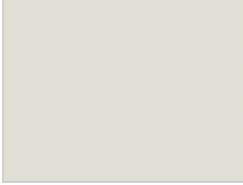
---

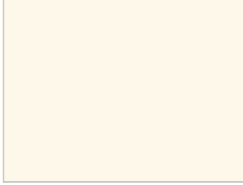
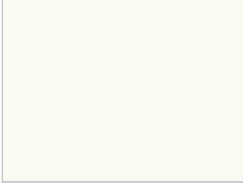

## FERRO

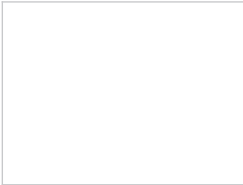
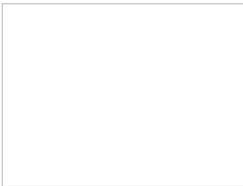
B2					
	ferro laccato: iron dust	ferro laccato: RAL - 1013_BIANCO PERLA	ferro laccato: RAL - 3020_ROSSO TRAFFICO	ferro laccato: RAL - 7035_GRIGIO LUCE	ferro laccato: RAL - 7037_GRIGIO POLVERE
					
	ferro laccato: RAL - 8019_MARRONE GRIGIASTRO	ferro laccato: RAL - 9001_BIANCO CREMA	ferro laccato: RAL - 9002_BIANCO GRIGIASTRO	ferro laccato: RAL - 9005_NERO INTENSO	ferro laccato: RAL - 9010_BIANCO PURO
					
	ferro laccato: RAL - 9016_BIANCO TRAFFICO				
B3					
	ferro laccato effetto spazzolato opaco: bronzo antico	ferro laccato effetto spazzolato opaco: acciaio	ferro laccato effetto spazzolato opaco: titanio		
B4					
	ferro laccato: RAL speciale				
B5					
	ferro laccato: bronzo nuvolato				

## LEGNO

A1

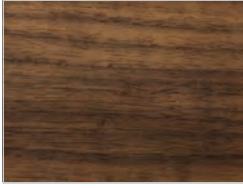

noce senza nodi



noce con nodi

A2

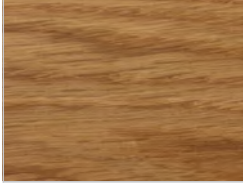

rovere senza nodi



rovere con nodi

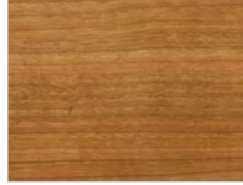

ciliegio

A4



rovere senza nodi pigmentato:  
bianco latte

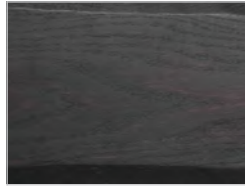

rovere senza nodi pigmentato:  
total black



rovere con nodi pigmentato:  
bianco latte



rovere con nodi pigmentato:  
total black